



***GSP-2800/2900  
Fixed Satellite Phone  
Installation Guide***

This guide is based on a version of the QUALCOMM Globalstar  
GSP-2800/2900 Fixed Satellite Phone. Software changes may have  
occurred after this printing.

QUALCOMM reserves the right to make changes in technical and  
product specifications without prior notice.

QUALCOMM Incorporated  
5775 Morehouse Drive  
San Diego, CA 92121-1714  
U.S.A.  
Document Number 80-98052-1EN Rev. A  
Model Number CKABS0001

Copyright 1999 QUALCOMM® Incorporated.  
All rights reserved.

This technology was exported from the United States in accordance with  
the Export Administration Regulations. Diversion contrary to U.S. law  
prohibited.

QUALCOMM® is a registered trademark of QUALCOMM Incorporated.  
Globalstar™ is a trademark of Loral Qualcomm Satellite Services, Inc.  
All other trademarks are property of their respective owner.

Printed in the United States of America.

**Contents**

<b>Introduction</b> .....	<b>1</b>	<b>Step 8. Run indoor wiring for the telephone and data</b> .....	<b>28</b>
The basics of good antenna location .....	1	Connect interior wiring to jacks and telephones .....	28
Globalstar is different .....	1	Connect interior wiring to the junction box .....	28
Can I mount the RAU on the side of a building? .....	2	Selecting a telephone .....	29
Fine points of antenna location .....	2	<b>Step 9. Connect power supply</b> .....	<b>30</b>
Power lines .....	3	QUALCOMM Power Supply, Model GPO-1000 .....	30
Television antennas .....	3	AC to DC Converter .....	30
Trees .....	3	Motor Generator .....	30
Chimneys .....	3	Battery Power .....	30
Seemingly hopeless situations .....	4	Solar Power .....	30
<b>Step 1. Safety considerations</b> .....	<b>5</b>	<b>Step 10. Connect power and test</b> .....	<b>32</b>
General .....	5	Make sure that all cables are connected .....	32
Power .....	5	Check cable connections .....	32
Batteries .....	5	Turn on power and perform power checks .....	33
Lightning .....	6	Final check .....	33
<b>Step 2. Inventory</b> .....	<b>7</b>	<b>Step 11. Troubleshooting</b> .....	<b>34</b>
Check the contents of the QGFSP package .....	7	<b>Terminology</b> .....	<b>35</b>
Base Kit .....	7	<b>References</b> .....	<b>35</b>
Enhanced Kit .....	9	<b>Appendix A. Standard practices for grounding</b> .....	<b>36</b>
Make sure you have all supplies and equipment .....	10	Ground rods .....	36
Grounding Accessories .....	10	Separate RAU ground equipment .....	36
<b>Step 3. Plan where to position the components</b> .....	<b>12</b>	Ground rod terminations .....	36
How to use the sighting tool .....	13	<b>Appendix B. Specifications for Cables</b> .....	<b>39</b>
Materials needed .....	14	Conductors .....	39
Radio Antenna Unit .....	14	Insulation .....	39
Junction Box .....	14	Jacketing .....	39
Power Source .....	15	Environmental Requirements .....	39
<b>Step 4. Prepare the RAU</b> .....	<b>16</b>	Performance Criteria .....	39
Security Module .....	17	Cable Construction .....	40
<b>Step 5. Mount the RAU on a pole or wall</b> .....	<b>18</b>	<b>Appendix C. Operating Specifications</b> .....	<b>41</b>
Mounting the RAU to a pole .....	18	Power Specifications .....	41
Mounting the RAU to a wall .....	20	Mechanical Specifications .....	41
<b>Step 6. Ground the QGFSP</b> .....	<b>21</b>	RAU .....	41
Pole Mount .....	21	Antenna .....	41
Grounding .....	21	Environmental Specifications .....	41
Lightning Protection .....	23	RAU .....	41
<b>Step 7. Install the junction box</b> .....	<b>25</b>	<b>Appendix D. Third Party Equipment</b> .....	<b>42</b>
		Product: SunWize™ Power Ready Systems .....	42

## **List of Figures**

Figure 1.	General RAU pole mount installation .....	1
Figure 2.	Roof mounted RAU .....	12
Figure 3.	Pole mounted RAU .....	12
Figure 4.	Incorrect placement of RAU .....	12
Figure 5.	Sighting Tool .....	13
Figure 6.	Locating possible obstructions .....	13
Figure 7.	RAU with cover removed .....	16
Figure 8.	Detail of P clip .....	16
Figure 9.	Detail of RAU inside .....	17
Figure 10.	SM Card and holder .....	17
Figure 11.	Lift the socket cover .....	17
Figure 12.	Insert the SM .....	17
Figure 13.	Attach the RAU to the pole .....	18
Figure 14.	RAU with wall mounting bracket in place .....	20
Figure 15.	Attach primary grounding cable to RAU .....	21
Figure 16.	Ground wire/ground rod connector .....	21
Figure 17.	Ground the junction box .....	22
Figure 18.	Grounding elements .....	22
Figure 19.	Service provider access closed .....	25
Figure 20.	Service provider access open .....	26
Figure 21.	RAU cable .....	27
Figure 22.	Indoor connection .....	28
Figure 23.	Jack .....	28
Figure 24.	Wiring for power supply .....	30
Figure 25.	Suggested installation for solar power .....	31
Figure 26.	Troubleshooting .....	34
Figure 27.	Grounding a building with existing lightning protection .....	38

## ***List of Tables***

Table 1.	Base Kit .....	7
Table 2.	Mounting Kit .....	8
Table 3.	Enhanced Kit .....	9
Table 4.	Grounding Supplies .....	10
Table 5.	Interior wiring .....	10
Table 6.	Power Supply .....	11
Table 7.	Tools .....	11
Table 8.	Connections .....	16
Table 9.	Recommended materials for wall mount .....	20
Table 10.	Grounding elements* .....	23
Table 11.	Wiring from RAU to junction box .....	27
Table 12.	Wiring from interior to junction box .....	28
Table 13.	Conductor Requirements .....	39
Table 14.	Environmental Requirements .....	39
Table 15.	Performance Criteria .....	39
Table 16.	Cable Construction .....	40
Table 17.	Power specifications .....	41
Table 18.	Mechanical specifications .....	41
Table 19.	Antenna .....	41
Table 20.	Environmental specifications .....	41

## Introduction

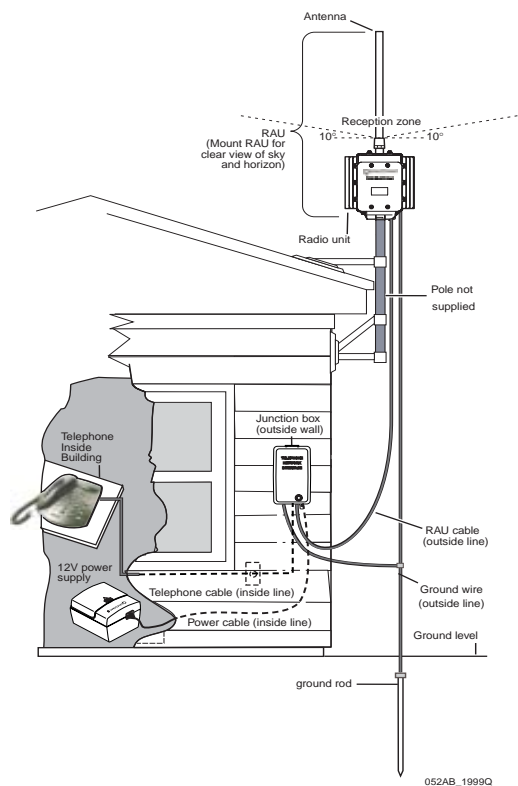

Figure 1. General RAU pole mount installation

Installing a QUALCOMM Globalstar Fixed Satellite Phone (QGFSP) is not the same as installing a telephone or a satellite dish for television. For example:

1. The RAU must have a clear view of the entire sky or it will not work. The antenna of the RAU should have an unobstructed view of the sky down to 10 degrees above the horizon (see Figure 1).
2. Grounding of the entire QGFSP system is vital and must be done correctly in order to protect the QGFSP and the people who use it. If the RAU, junction box, or wiring are improperly installed, or if the system is not properly grounded, there is, in extreme circumstances, risk of fire, personal injury, or death.

This guide explains how to install the components of the QGFSP. In this guide, we call the complete unit, including the telephones, the QGFSP. When we talk about the QGFSP, we are talking about the entire Globalstar installation.

Figure 1 shows an example of how the radio antenna unit (RAU) and junction box might be installed using a pole mounted on the outside of the building.

### *The basics of good antenna location*

It is important that you install the RAU in a good location. But just what is a good location? Read on. We'll try to explain.

The antenna of the RAU needs to have a direct line of sight to the Globalstar satellites. That means it needs to be able to see the sky with nothing in the way.

You may be familiar with television satellites that are in a fixed location in the sky. For those satellites, you can aim an antenna at one place, and it doesn't matter whether you have a clear shot to any other part of the sky.

### *Globalstar is different*

Globalstar satellites move. They come up over the horizon, zip across the sky, and then drop behind a hill. They follow different paths.

Because you don't know what part of the sky the satellites will be in, you need to find an RAU location where the antenna can see as much of the sky as possible. The rule is that the antenna of the RAU should see the entire sky down to 10 degrees above the horizon.

The QGFSP and satellites use a different kind of radio signal: high frequency microwave signals. Unlike television and AM or FM radio signals, or even cellular phone signals, microwave radio signals do not bend. They are strictly line of sight. This means that these signals do not go through walls. They do not go around hills or through trees or over bushes. If something gets between the satellite and the QGFSP, the phone won't work.

Be sure to install the QGFSP such that there are no objects blocking the view of the sky. To help you figure out if objects are above 10 degrees or below 10 degrees, you can use the sighting tool that is included in your kit. Use of the sighting tool is explained in How to use the sighting tool on page 13.

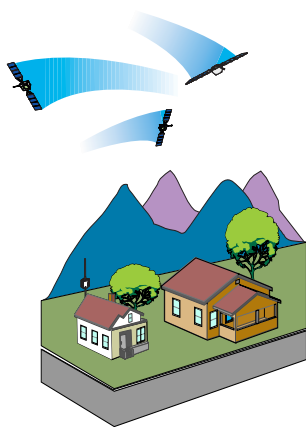

Sometimes it won't be possible to get such a full clear view. In that case, you should try to find a location that gets as full and clear a view of the sky as possible.

#### ***Can I mount the RAU on the side of a building?***

Generally no. Mounted on the side of a building, the antenna would only see half the sky. However, you could mount a mast bracket on the side of a building, then extend the mast up above the

roof, and mount the RAU there. See Figure 1 on page 1 for how that could be done.

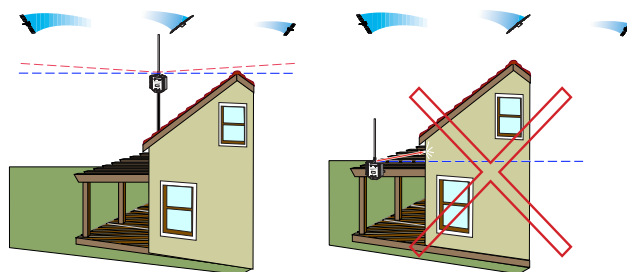

#### ***Fine points of antenna location***

As we said before, the Globalstar satellites are always moving. They zip across the sky, taking from 10 to 15 minutes to go from horizon to horizon. Sometimes a person will install an RAU in a bad location, and be fooled into thinking the installation is correct just because he was able to make a good phone call. Don't be fooled! Just because you can make a call now doesn't mean you will be able to make a call a few minutes later when the satellites have changed position. The only way to ensure that the QGFSP will work reliably and consistently is to make sure that the antenna of the RAU can see most of the sky. You can't tell a good location from a bad location by making a test call.

Sometimes it is very difficult to find a location where there is nothing at all in between the antenna and some part of the sky. Some obvious challenges are trees, power lines, television antennas, and lightning rods. The ideal location has nothing in the way. However, some things can sit in the path between our RAU antenna and the satellite without causing harm.

### Power lines

Power lines are usually not a problem. As long as the RAU is at least 10 feet away from the power lines, the signal will be able to go through the power lines without a problem. Power poles can block the signal however. Try to avoid having power pole blockage. If it is impossible to avoid power pole blockage, try to locate the Globalstar RAU as far from the power poles as possible.

### Television antennas

Many homes have tall television antennas on their roofs. It would often be quite difficult to put the RAU high enough to avoid having the television antenna in the way. Good news! You do not have to put the RAU higher than the television antenna. If you locate the RAU at least 10 feet away from the television antenna and mast, the television antenna and mast will not cause blockage. (This presumes a standard 1 1/2 inch diameter television antenna mast. If, instead of a simple mast, you have a large antenna tower, then you should try to locate the Globalstar antenna farther away.)

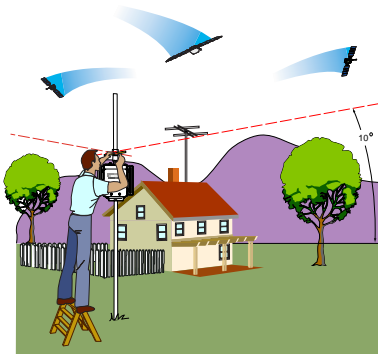

### Trees

Trees are almost always bad for satellite reception. Try to avoid them. The Globalstar signal will go through some thin trees. However, trees will grow, and the problem will get worse over time. Trees also cause much more blockage when they are wet. The signal may find its way through the trees this afternoon, but have more trouble in the evening after the sun sets and dew forms on the leaves. Try to avoid having trees in the way of your satellite signals.

If a house is surrounded by trees, you should consider putting the Globalstar RAU on a mast, extended up from the roof of the house. Ideally, the mast would be tall enough so that the antenna of the RAU can see most of the sky.

### Chimneys

The Globalstar signal will not go through a chimney. If you mount the antenna on the side of a chimney, the signal will not be able to go through the chimney, so the antenna would only see half the sky. That's bad.

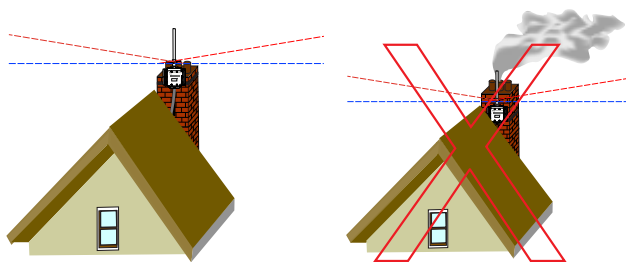

If you attach a mast to a chimney mount, then extend the antenna of the RAU above the chimney, you may have a good installation. However, soot from the chimney may accumulate on the antenna over time. Soot contains carbon that will block the signal! Soot buildup will cause problems. If your fireplace burns anything but gas, avoid putting your RAU in that location. If the chimney is fed

only by residential gas appliances, then installing the RAU there may be acceptable. Extend the mast a few feet above the chimney so that hot gasses from the chimney don't damage the antenna.

***Seemingly hopeless situations***

Sometimes there are situations that you just can't get around. In that situation, do the best you can do. At moderate latitudes (between latitude 22 degrees and 52 degrees) there will always be two satellites visible in the sky at any location. That means if an object blocking the antenna's view of the sky is small (that is, blocks a small part of the sky), it should never, or almost never, cause an outage. Good luck!



## Step 1. Safety considerations

We recommend that installation, repair, and maintenance of the QGFSP be performed by technically qualified service personnel; that is, those selected and trained by the service provider or QUALCOMM.

### General



#### Warning

Failure to follow the warnings and instructions included in this guide can lead to serious personal injury or death and possible property damage.



#### Warning

Never insert objects through openings in the equipment. Conductive foreign objects can produce a short circuit that could cause fire, electrical shock, or damage to the equipment.



#### Warning

REGULATIONS. Installation of this QGFSP must meet the local codes and regulations for lightning installation.



#### Caution

Changes or modifications not expressly approved in this guide could void the warranty for the QGFSP.



#### Caution

There are no end-user serviceable parts. Repairs should be made by the service provider or a QUALCOMM approved repair center.



#### Caution

Before installing the equipment, remove jewelry and other metallic objects from your person. These items can cause electrical shock or burns.

### Power



#### Warning

High current 12 volt power supplies and batteries can be dangerous unless installed correctly. Install all cables and wiring and complete all connections before applying power. Never install or work with wires when power is connected.



#### Warning

Avoid any AC power lines that may be in the vicinity. Avoid installing the RAU and its connecting cables in any location where accidental contact with AC power lines may occur.

### Batteries



#### Warning

Do not store unsealed lead-acid batteries inside the building. If the QGFSP is powered from an alternate source, such as a car battery, the installer must provide suitable overcurrent protection, as well as venting, to safely dissipate flammable hydrogen gas that might leak from lead-acid car batteries. Overcurrent protection must be certified and rated at least 20 VDC and no more than 3 A (amps).

## Lightning



### Warning

Even though a properly installed QGFSP includes grounding and circuitry to help minimize damage to equipment, facilities, and personnel from nearby lightning, lightning is a highly unpredictable and dangerous phenomenon. It is impossible to completely protect equipment and personnel from lightning strikes. During electrical storms (thunderstorms):

- Do not use the telephone
- Do not connect a computer to the RAU for the purposes of QGFSP service programming
- Do not modify the QGFSP or related equipment



### Warning

In areas of severe lightning activity, QUALCOMM recommends use of a separate primary lightning protection system, such as a lightning rod, to protect the antenna unit and associated equipment from lightning strikes. Failure to properly install the QGFSP or to include a separate lightning protection system may cause electrical shock, fire, or damage to equipment. See Figure 27 for recommended installation in conjunction with a lightning protection system.

## Step 2. Inventory

### Check the contents of the QGFSP package

The RAU is a QUALCOMM-manufactured aluminum housing containing Globalstar radio electronics and an integrated mast antenna protruding from the top of the housing.

Two kits are available:

- The **base kit** contains the RAU, junction box, security module (SM) card, a sighting tool, 10 crimp rings, a documentation package, and a mounting kit. Note that when you purchase the base kit, you must purchase other needed items.
- The **enhanced kit** contains all items of the base kit, plus telephone, cabling, power supply, and backup battery for the power supply.

### Base Kit

Items contained in the base kit are listed in Table 1.

Item	Description
	<p>One radio antenna unit (RAU) with attached antenna.</p>



Item	Description
	<p>One junction box. The junction box is the interface between the outside cables and the inside telephone wires.</p>
	<p>One security module on a card. If the SM card was not installed in the factory, the service provider should supply one.</p>
	<p>One sighting tool. Use this to determine correct placement of the RAU.</p>
	<p>Ten crimp rings: five blue (16 to 14 AWG), four yellow (26 to 24 AWG) and one blue (6 AWG). Use these rings to connect cable to connectors in the junction box.</p>

**Table 1. Base Kit**





Item	Description
	A documentation package containing an installation guide, a user guide, and a quick reference card. The user guide and quick reference card should be given to the user of the QGFSP.
	A mounting kit, described in Table 2 on page 8.

A mounting kit is shown in detail in Table 2. The mounting kit is included with both kits.

**Table 2. Mounting Kit**

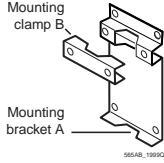
Item	Description
	One U bolt for use in mounting to a pipe. Bolt accommodates pipe sizes ranging from 38 mm (1.50 inch) outside diameter (OD) to 48 mm (1.90 inch) OD.
	Two M6 x 60 mm pan head screws.

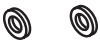
**Table 2. Mounting Kit**

Item	Description
	Two M6 x 16 mm pan head screws.
	One mounting bracket (A) and one mounting clamp (B). Mounting clamp B is used only when mounting the RAU to a pole.
	Two hex nuts. Used to lock U bolt in place.
	Flat washers. Sufficient for number of screws enclosed.
	Split lock washers. Sufficient for number of screws enclosed.

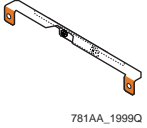

**Table 2. Mounting Kit**

Item	Description
 <p>781AA_1999Q</p>	<p>One mounting bracket for mounting the RAU to a wall.</p>



**Enhanced Kit**

The enhanced kit includes all the items of the base kit, plus the items shown in Table 3. These items can also be purchased separately.

**Table 3. Enhanced Kit**

Item	Description
 <p>555AB_1999Q</p>	<p>Fifteen meters (50 feet) of wiring to connect the junction box to the RAU. The wire can be shortened, if desired. (included in kit)</p>
 <p>553AB_1999Q</p>	<p>QUALCOMM +12V power supply with 2.44 meter (8 foot) DC output line cord (two line cords, one with a European plug and one with a U.S. plug are included in the kit)</p>

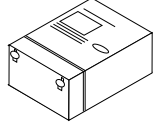
**Table 3. Enhanced Kit**

Item	Description
 <p>554AB_1999Q.eps</p>	<p>Backup battery for use with QUALCOMM power supply. The backup battery offers 3.5 hours talk and 24 hours of standby.</p>
 <p>556AB_1999Q</p>	<p>Telephone with phone cable and RJ-11 connector.</p>

## Make sure you have all supplies and equipment

Check to see which QUALCOMM kit you are installing. Depending on the kit purchased, you may need additional items to complete the installation.

## Grounding Accessories

Grounding accessories available from electrical supply companies are not included in the kit; however, they are required to ground the RAU and junction box. Quantities required in a typical installation are shown in Table 4. In addition, the installer should supply the pole needed to support the RAU.



### Note

If fabricating your own 15-meter (50-foot) cable for connecting the RAU to the junction box, the cable must conform to specifications given in Appendix B. Specifications for Cables. Specifications for fabricating cables must be followed to avoid damage or poor performance of the equipment and to avoid invalidating your warranty.

**Table 4. Grounding Supplies**

Type	Quantity needed
#6 AWG copper primary ground cable	Amount needed depends on site
#6 AWG (pink) ground lug	1 each
#6 AWG solid copper ground wire used to ground junction box	0.5 meter (1.6 feet)
Copper C-type compression tap (#6 to #6 wire)	1 each
2.7 to 3 meter (8 to 10 foot) ground rod	1 – length depends on soil type

**Table 4. Grounding Supplies**

Copper clamp, #6 AWG wire to ground rod, screw type	1 each
Bolts to secure grounding wiring to rod	As needed
Wall mounting brackets and fittings	If needed
RAU to junction box cable (provided by QUALCOMM or the equivalent cable) See Appendix B. Specifications for Cables.	As needed. Not to exceed 15 m (50 feet).
Pole for mounting	If needed
Cable ties	As needed

Table 5 lists the wires and jacks recommended for use in installing the interior wiring.

**Table 5. Interior wiring**

Recommended item	Quantity needed
Standard telco cable	As needed to a maximum of 182 meters (597 feet)
6-position modular jack, wall mount (EIA-568 or EIA-520) RJ-11	As needed
Wiring boxes	1 each

Table 6 lists sources for power supplies.

**Table 6. Power Supply**

Item	Quantity needed
Power supply: 12 volt, 3 A. Possible power sources that can be used are: <ul style="list-style-type: none"> <li>■ Solar panel producing 12 VDC with optional backup battery*</li> <li>■ Motor generator (2-wire terminal for 12 VDC)</li> <li>■ AC to DC converter operating at 100 to 240 VAC, 50/60 Hz with 12 V DC output</li> </ul>	Select one.
* For solar power, QUALCOMM recommends SunWize™. Their products have been tested. They are considered suitable for use with QUALCOMM's QGFSP.	

Table 7 lists the tools needed to complete the installation.

**Table 7. Tools**

Item	Quantity needed
Tools for installation <ul style="list-style-type: none"> <li>■ Crimping tool</li> <li>■ Phillips screwdriver (#2)</li> <li>■ Torque wrench</li> <li>■ Cable ties</li> <li>■ Needle-nose pliers</li> <li>■ Socket wrench set, metric and English sockets</li> <li>■ Bubble level</li> <li>■ Plumb line</li> </ul>	As needed
Mounting hardware for junction box: wood and metal screws with nuts and bolts	As needed

### Step 3. Plan where to position the components

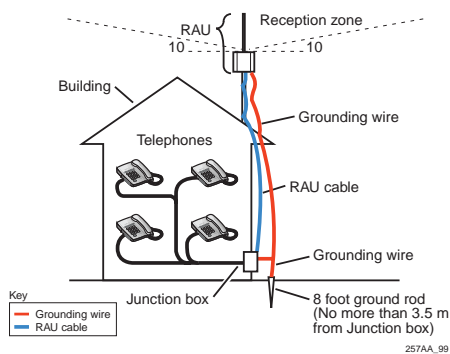

Figure 2. Roof mounted RAU

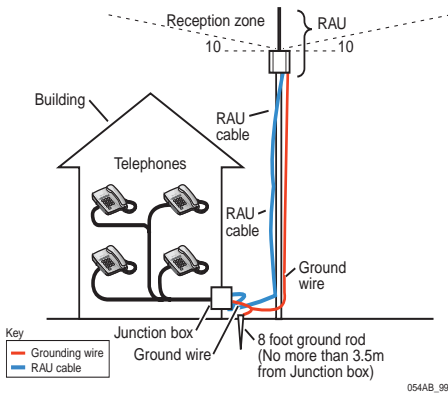

Figure 3. Pole mounted RAU

Determine where to position the QGFSP components and decide which mount is best suited to the current work site. Be certain that the RAU antenna has a clear view of the sky, that you have provided adequate grounding, and that you have the correct number and lengths of cable.

- Two recommended mounting configurations are shown in Figure 2 and Figure 3. A poor choice for mounting is shown in Figure 4. Note that in the figure, reception is blocked both by building and by tree.
- Use the sighting tool to help determine whether there are obstructions to satellite reception. (See page 13 for instructions.)
- Plan how to ground the QGFSP. If there is an existing lightning protection system, see Figure 27 on page 38 for how to install the QGFSP.
- Position the junction box on the outside of the building, near where the inner telco wires meet the outside, and close to the grounding rod.
- Be certain that cable lengths will be adequate. Recommendations are on page 14.

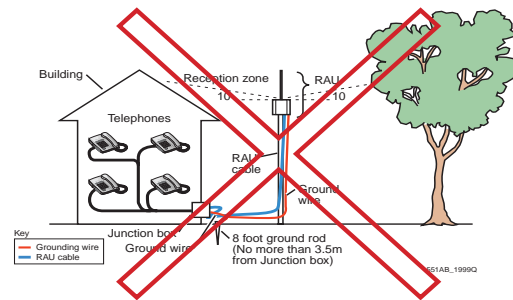

Figure 4. Incorrect placement of RAU

## How to use the sighting tool

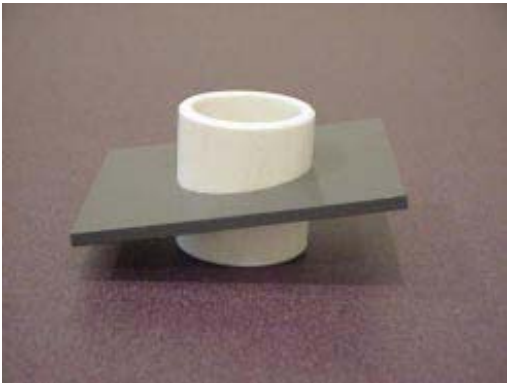

Figure 5. Sighting Tool

The sighting tool is included in the basic kit to give you an easy method of determining 10 degrees over the horizon. To use the sighting tool:

1. Position the RAU in its desired location.
2. Place the sighting tool over the antenna, allowing it to slide to the bottom of the antenna.
3. If the antenna is in a vertical position, the flat plate will be at a 10 degree angle. With the lower end of the sighting tool closest to your eye, sight along the flat plate and note what you see over the upper end of the plate.
4. Rotate the sighting tool in a full circle to ensure there is a clear view of the sky in every direction. Anything you see above the upper end of the plate will be in the way of satellite signals.
5. When finished, remove the sighting tool.



Figure 6. Locating possible obstructions

In this case, there is a wall obstructing the view.

## Materials needed

Because each installation is different, some materials and supplies for mounting the RAU are provided by the installer. This includes a pole for mounting the RAU and any materials needed to mount the junction box on the building. See the following tables:

- Table 4 on page 10
- Table 5 on page 10
- Table 8 on page 16
- Table 9 on page 20

## Radio Antenna Unit

1. When installing the RAU, use a plumb line to ensure that the antenna is vertical.
2. Mount the RAU on a roof or pole high enough to ensure that the entire antenna has a clear view of the horizon in all directions for maximum satellite visibility. The antenna can acquire satellites that appear 10 degrees or more above the horizon.

### Note

If mounted on the roof, the entire antenna must be fully above the roof so that it has an unobstructed overhead view and a 360 degree view of the horizon. It is acceptable to mount the RAU in proximity to a lightning rod that may be taller than the RAU. See Figure 27 on page 38.

3. Ensure that the RAU is located within 15 meters (50 feet) of the bottom (cable entry side) of the junction box.

## Junction Box

1. Secure the junction box to the outside of the building. The junction box is the demarcation point between the indoor (telephone and wiring) and the outdoor (RAU and cabling) components. The junction box and ground rod provide the user with protection against lightning strikes both to the RAU and

outdoor cabling. Mount the junction box to the dwelling at the point of entry of wiring into the building.

2. Mounting hardware is not provided with the junction box. Ensure that all cabling designed for use indoors is kept inside the premises and all cabling designed for use outdoors is kept outside the premises. It is acceptable for outdoor cabling to enter the interior of the building; however, interior cabling should never be used outdoors.
3. Install the junction box so that the bottom of the junction box is within 15 meters (50 feet) of the RAU.

The configuration should also take into consideration

- The maximum length of cable between the RAU and the farthest telephone is 182 meters (600 feet)
- The maximum number of telephones that can be installed is limited to 5.0B REN per Bellcore TA-NWT-909
- The RAU requires a 12 VDC, 3 A power supply for operation (10.5 to 16 volts as measured at the junction box)
- The maximum length of cable between the power supply and junction box is 7 meters (23 feet)
- The junction box should be positioned close to the ground rod. The maximum length of cable between junction box and ground rod is 3.5 meters (11.5 feet)

This assumes use of a maximum of 15 meters (50 feet) of cabling, provided in the enhanced kit or its equivalent, as specified in Appendix B. Specifications for Cables.

### Note

If the building is not already wired for telephone service, the installer should do this as part of the installer's service.

## Power Source

The power source is determined by the service provider or the service provider's representative. Possible power sources are:

- Power supply producing 12 VDC with backup battery such as a AC to DC converter operating at 110V to 220V AC, 50/60 Hz, with 12 VDC nominal output, capable of sourcing at least 3 A.
- Solar panel producing 12 VDC (nominal) with optional backup battery and capable of sourcing at least 3 A.
- Motor generator (2-wire terminal for 12 VDC), with 3 A output source capability.



### Note

QUALCOMM recommends using the shortest length of wire practical between the power supply and the RAU to keep voltage drop between the power supply and RAU to a minimum, particularly if the supply voltage is closer to 10.5 volts.

Regardless of wire length, the installer must ensure that supply voltage is not less than 10.5 volts or more than 16 volts at the junction box. The RAU draws a load that varies between 0 and 3 A.

If the installer uses the 15 meter (50 foot) RAU to junction box cable provided with the enhanced kit, and the power supply maintains an output of at least 10.5 volts, then proper voltage at the RAU is assured.

## Step 4. Prepare the RAU

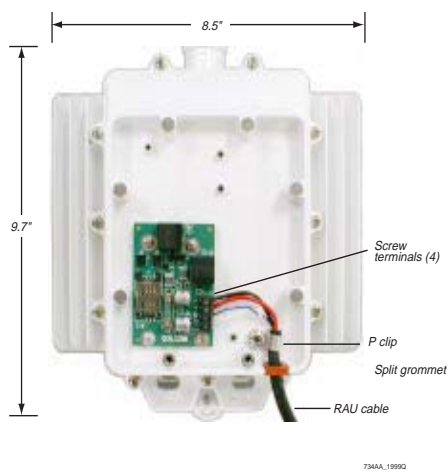

Figure 7. RAU with cover removed

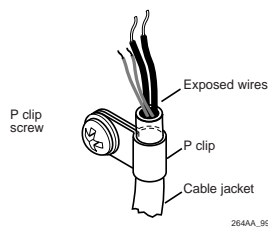

Figure 8. Detail of P clip

1. Remove the access cover from the RAU by unscrewing the captive thumbscrews at the top and bottom of the unit.



### Warning

Do not open the other part of the RAU. To do so voids the warranty. There are no user/installer fixable parts there. Opening other parts of the RAU leaves the unit vulnerable to damage from the environment.

2. Run the RAU cable from the bottom of the junction box to the RAU. Connect the wire to the RAU using information in Table 8. See Figure 9 on page 17 for details.

Table 8. Connections

Wire	Screw Terminal	Signal
Black	-	+12 V supply return
Red	+	+12 V supply source
Blue	R	Ring
White	T	Tip

3. Remove the grommet at the bottom right of the RAU and slip it over the free end of the cable at the end near the connectors, as shown in Figure 7.
4. The P clip secures the cables in the RAU housing. Using a Phillips screwdriver, loosen the P clip (Figure 8). Push the cable through the bottom of the RAU and through the P clip so that the P clip encircles the cable jacket. Screw down the P clip loosely.



**Note**

Do not tighten the P clip until all other connections are in place. This allows some flexibility while you make other connections. Tighten the P clip when ready to close the access cover. When the connectors are in place, ensure that the grommet is in place in the hole on the bottom right side of the RAU. This provides protection from the weather.

5. Fit the grommet so that it seals the hole in the chassis.
6. When steps 1 through 4 are complete, torque the P clip screw to  $220 \pm 30$  N-cm ( $19.5 \pm 2.7$  in lb).

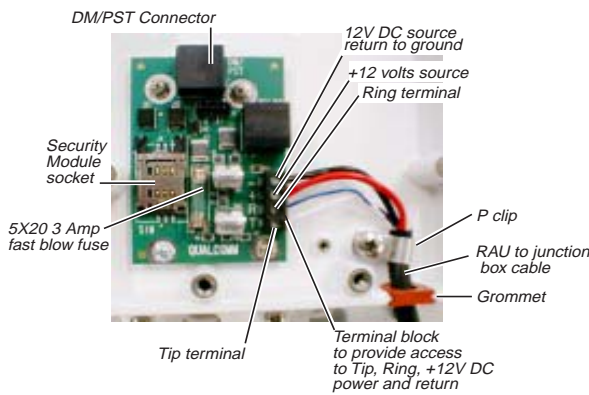

Figure 9. Detail of RAU inside



**Note**

The cable used to supply power to the RAU shall be composed of a pair of copper wires of a size no less than 14 AWG. The cable used to supply power to the RAU shall not exceed 15

meters (50 feet) in total length, including all cable from the power supply to the RAU.

**Security Module**

If not already done in the factory, insert and secure the security module (SM) card in the socket provided. Refer to Figure 10, Figure 11, and Figure 12 for placement.

1. Open the bag and take out the SM Card. Gently detach the SM on the left side of the card.
2. Locate the socket for the security module and gently lift it up.
3. Take the SM, hold it Globalstar side up with the cropped corner toward the hinge of the cover.
4. A holder for the SM is under the cover. Gently slide the SM into the holder on the cover of the socket. When the SM is secure in the socket cover, close it until the cover clicks into place.
5. If you inserted the SM correctly, a small amount of the SM shows outside the cover.



Figure 10. SM Card and holder



Figure 11. Lift the socket cover



Figure 12. Insert the SM

Mount the RAU on a pole or wall

## Step 5. Mount the RAU on a pole or wall

### Mounting the RAU to a pole

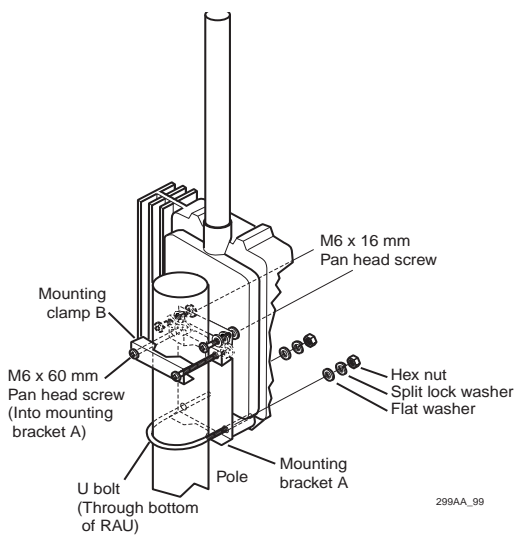

Figure 13. Attach the RAU to the pole

The RAU is approximately 750 cm (29.5 inches) tall and weighs 3.04 kg (6.7 lb.), not including cables or mounting hardware. The RAU can be mounted to a user-provided pole. The chosen pole must be capable of supporting the RAU and associated cabling during periods of severe inclement weather.

The installation kit contains the appropriate connectors for mounting the RAU to a pole ranging in size from 3.8 cm (1.50 inch) OD through 4.8 cm (1.90 inch) OD. The kit does not include the pole. To install the RAU on a pole, you will need the U bolt, assorted screws, and the metal mount (2 pieces). Figure 13 shows a typical pole mount.

You will need a #2 Phillips screwdriver, a torque wrench, and a 9/16 socket wrench.



#### Warning

Ensure that the RAU and the pole are located a safe distance from AC power lines. Use caution when working with ladders and other equipment around power lines.



#### Caution

While installing the RAU on the pole, support the RAU until all mounting hardware is in place and secured, and the RAU is securely mounted on the pole.

1. Take the larger piece of the mount (mounting bracket A on Figure 13) and use the short M6 x 16 mm screws to attach the mount directly to the RAU, using the holes provided on the back of the RAU.

Washers are provided for the short M6 x 16 mm screws. Place the split lock washer next to the screw head followed by the flat washer before inserting the screws. Tighten the M6 x 16 mm screws to  $300 \pm 30$  N-cm ( $26.6 \pm 2.7$  in lb). Using Figure 13 as a placement guide, be sure that the large oval holes on the mounting pieces and the RAU are lined up.

2. Washers are provided for the long M6 x 60 mm screws. Place the split lock washer next to the screw head followed by the flat washer before inserting the screws. Using the smaller piece of mount (mounting clamp B on Figure 13), insert the two long M6 screws through it. As shown in Figure 13, connect the mounting clamp B with mounting bracket A using the long M6 screws to connect the two pieces.

Mount the RAU on a pole or wall

The nuts for the long M6 screws are already included as part of mounting bracket A. Do not tighten the screws completely until you have mounted the RAU on the pole.

3. Fit the U bolt through the oval holes in mounting bracket A, then insert the U bolt through the RAU until the threaded ends appear at the bottom front of the RAU. Place the large flat washers, the large split washers, then the hex nuts on the ends of the U bolt with stack-up shown in Figure 13 on page 18. (When the access cover is closed, the hex nuts on the U bolt will be hidden.)
4. Slip the RAU assembly over the top of the pole. Tighten the long M6 x 60 mm screws to  $300 \pm 30$  N-cm ( $26.6 \pm 2.7$  in lb). Tighten the U bolt hex nuts to  $1536.5 \pm 248.6$  N-cm ( $136 \pm 22$  in lb). Ensure that now the RAU cannot move while on the pole.



**Note**

Ensure that the pole, the RAU, and the antenna are vertical and that the antenna has a clear view of the sky and a 360 degree view of the horizon. Ensure that the entire length of the antenna portion of the RAU clears the top of the pole.

Ensure that there is no possibility that the RAU can move or slip while mounted on the pole.

5. To close the access cover, hook the cover in the recess at the top of the RAU front housing. Draw the access cover down over the access opening and tighten the four thumb screws on the cover to  $220 \pm 30$  N-cm ( $19.5 \pm 2.7$  in lb).



**Note**

For protection against weather, the grommet must be installed correctly and the screws that close the access cover must be tight.

6. If desired, use a padlock to secure the cover and prevent theft of the SM card and RAU.



**Warning**

**POWER.** Do not apply 12 volt power until all electrical connections are made. Do not allow the +12 volt line to contact the ground wire or any other metallic object. Should a short occur, there is a risk of injury, fire, or damage to power supply, and explosive venting of any backup battery.

Mount the RAU on a pole or wall

## Mounting the RAU to a wall

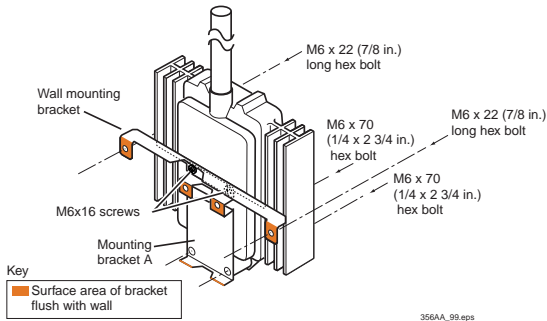

Figure 14. RAU with wall mounting bracket in place

If desired, the RAU may be mounted to a wall using the wall mounting bracket shown in Figure 14. This wall mounting bracket is included in the mounting kit.

1. For this type of installation you will need mounting bracket A, the wall mounting bracket and the two M6 X 16 mm screws. In addition, you will need the fasteners recommended in Table 9.
2. Attach mounting bracket A to the wall mounting bracket using the M6 X 16 mm screws. A detail of the mounting bracket is shown in Table 2 on page 8.
3. Attach the wall mounting bracket to the wall. The hex bolts used to connect the wall mounting bracket to the wall must fit the bracket and be of the appropriate length and type for the composition of the wall at the chosen installation site.
4. Attach the bottom of the RAU and mounting bracket A using hex bolts at least 44 mm (1.75 in.) long. Start the hex bolts from the front of the RAU and continue through the oval holes and on through mounting bracket A.

Keep in mind that the entire antenna must have a clear view of the sky and the horizon in order to operate correctly. The antenna portion of the RAU must be above the building and not blocked in any way.

A recommendation of materials needed to anchor the RAU to a masonry or concrete wall is given in Table 9. These materials are provided by the installer.

Table 9. Recommended materials for wall mount

Quantity	Type
2	1/4 - 20 x 2 3/4 hex bolt, grade 5 (or metric equivalent)
2	1/4 - 20 x 7/8 hex bolt, grade 5 (or metric equivalent)
4	1/4 - 20 machine screw anchors (or metric equivalent)
4	1/4 SAE flat washer (or metric equivalent)

## Step 6. Ground the QGFSP

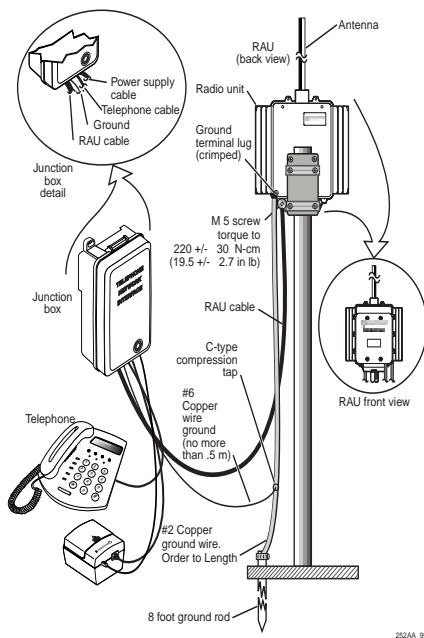

Figure 15. Attach primary grounding cable to RAU

The RAU is a metal object that is typically located high on a pole with a full view of the sky. There is the potential for it to be hit by lightning. Therefore, it is mandatory that you ground the RAU as described here and in detail in Standard practices for grounding on page 36.

To ground the QGFSP, follow these instructions carefully.

## Pole Mount

If the RAU is mounted on a metal pole whose lower end is buried deep in the ground, run the primary grounding cable directly from the RAU and bolt it to the pole. (See Figure 15 for details.)

## Grounding

Connect primary grounding cable to RAU and ground rod:

1. Secure the primary grounding cable to the RAU ground lug as shown in Figure 15. (The ground terminal lug is shown as B on Figure 18.)
2. Secure the primary grounding cable to ground rod using clamp shown in Figure 16. (The clamp is shown as F on Figure 18.) Tighten the large screws until the clamp is fastened securely to the 8 to 10 ft. ground rod.

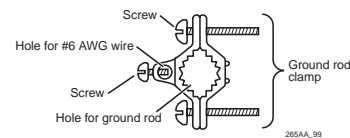

Figure 16. Ground wire/ground rod connector

More information about grounding is in Standard practices for grounding on page 36.

3. Connect the #6 ground wire to the junction box ground terminal, shown in Figure 17. Ensure that the ground rod allows for a 0.5 meter (1.5 foot) maximum cable length between the junction box ground terminal and point of connection to the primary ground cable. (The point of connection is shown as D on Figure 18.)

4. Connect the free end of #6 grounding wire to primary grounding cable. To accomplish this, use a C-type compression tap and crimping tool to secure primary grounding cable to #6 grounding wire. The length of the primary grounding cable from the #6 ground wire C-type compression tap to the ground rod (between points D and F in Figure 18) should not exceed 3 meters (10 feet) in length

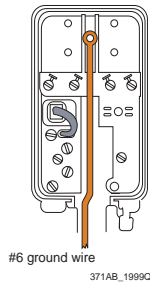

Figure 17. Ground the junction box

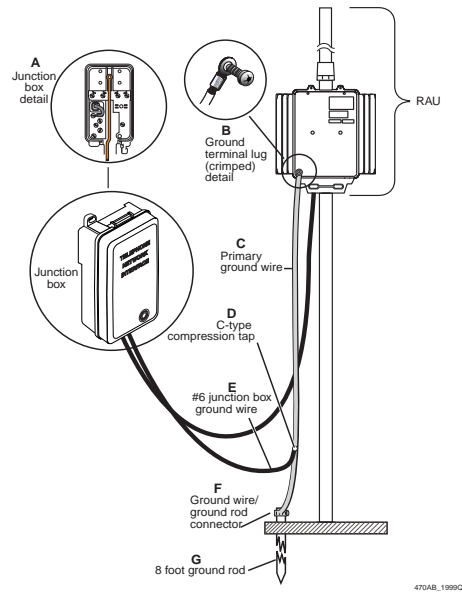

Figure 18. Grounding elements

(See also Table 10 on page 23.)

Table 10. Grounding elements\*

Item	Name	Description and Purpose
<b>A</b>	Ground terminal	Connection point on junction box for #6 grounding wire.
<b>B</b>	Ground lug	Connection point on RAU for primary grounding cable.
<b>C</b>	#6 AWG primary ground cable	Connects RAU to ground rod.
<b>D</b>	C-type compression tap	Secures #6 ground cable to primary ground cable.
<b>E</b>	#6 junction box ground wire	Connects junction box to RAU through connection to primary grounding cable.
<b>F</b>	Ground wire/ground rod connection	Hardware used to connect primary grounding cable. See Figure 2 on page 21.
<b>G</b>	Ground Rod	Device for grounding. It is buried in the ground 2.4 to 3 meters (8 to 10 feet) deep.

\* See Figure 19 on page 25 and Appendix A. Standard practices for grounding.

## Lightning Protection

- Connect the RAU ground wire to the RAU chassis using the ground screw on the lower rear face of the RAU. The screw holds the lug of the ground wire in rigid metal-to-metal contact with the surface of the chassis surrounding the screw head.
- If the RAU is mounted on a building that is not lightning protected or on a pole, run the grounding wire from the RAU down the pole next to the RAU cable and route it past the junction box. Then bolt it to a grounding rod; that is, a rod specifically designed to ground in this situation. Refer to Figure 27 on page 38 and Standard practices for grounding on page 36. Connect the 0.5 meter (1.6 foot) #6 AWG ground wire from the junction box to the RAU ground cable using the C-type compression tap and a crimping tool.
- If the RAU is mounted on a building that is lightning protected, run the primary grounding cable from the RAU past the junction box, then attach the junction box ground wire to the building lightning ground rod within the ground rod pit (see Figure 27 on page 38). Alternatively, run the RAU primary ground wire to its own separate ground rod. Connect the junction box ground wire to the primary ground cable using the C-type compression tap.



### Note

For almost all installations, QUALCOMM recommends using #6 AWG copper grounding cable for the RAU ground cable and for the ground wire securing the junction box grounding screw to the RAU primary ground cable (see Figure 17 on page 22). An C-type compression tap is recommended to bond the junction box ground wire to the RAU primary grounding cable. The junction box ground wire should be as short as possible.

The total length of cable from the junction box to earth ground must be less than 3.5 meters (0.5 meters from the junction box to the RAU ground cable plus 3 meters [10 feet] from the tap to the ground rod). If this is simply not possible for a particular installation, the RAU should be protected by a primary lightning protection system (lightning rod).

The lightning rod is typically installed as a building lightning protection system. See Figure 27 on page 38.



**Warning**

The installation of this QGFSP must meet the local code and regulations for lightning installation.



**Caution**

The lightning rod must have its own separate grounding cable. The lightning rod should be mounted at least 3 meters (10 feet) but not more than 25 meters (85 feet) away from the RAU with the lightning rod extending the same distance vertically above the tip of the RAU antenna as the horizontal distance between the lightning rod and the RAU. See Figure 27 on page 38.



**Caution**

If the RAU is hit by lightning, both the RAU and the junction box will very likely be permanently damaged. In areas of high lightning activity, a separate lightning rod is recommended. Refer to local codes for any additional requirements on proper installation with respect to lightning protection and grounding.

## Step 7. Install the junction box



Figure 19. Service provider access closed



### Note

The outside screw on the junction box cover disables the locking mechanism. If the junction box is not locked, you can open the junction box by pressing the tab located on the opposite side and lift the cover.



### Warning

Run indoor wiring from the junction box directly into the structure in the shortest distance practical. Wires from the junction box to the building interior should enter the building almost immediately after exiting the junction box. (See Figure 19.)



### Warning

Do not run RAU or junction box ground cables inside a building. The junction box is the interface between the outside cables and the inside cables. The junction box must be located on the outside of the building immediately at the point where the indoor cables reach the outside of the building.

When properly grounded, the junction box minimizes damage to the telephone and lowers the risk of injury to the user in the event the RAU or its cabling are struck by lightning in an electrical storm.

The junction box may not adequately protect the user if the RAU or its cabling are struck by lightning while the phone is in use. Therefore, QUALCOMM recommends that the equipment not be operated or handled during an electrical storm, except for brief calls in an emergency situation.



### Warning

Even though the QGFSP includes grounding and circuitry to protect equipment, facilities, and personnel from nearby lightning, lightning is a highly unpredictable and dangerous phenomenon. It is impossible to completely protect equipment and personnel from lightning.

Install the junction box

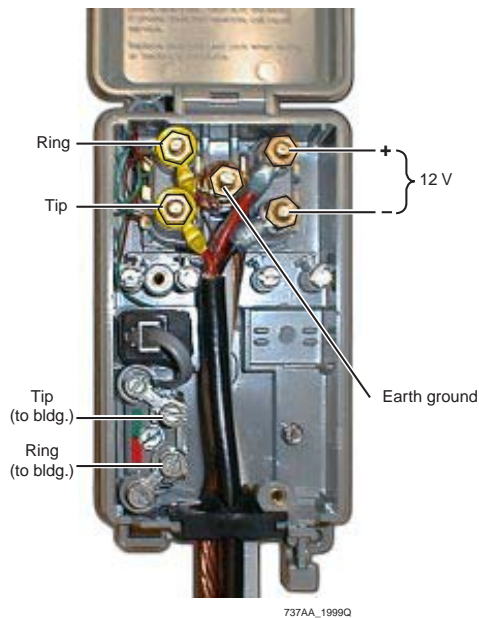

Figure 20. Service provider access open

1. The junction box is the interface between the outside and the inside cabling. The junction box must be located on the outside of the building immediately at the point where the indoor cables reach the outside of the building.
2. With appropriate screws (not included), mount the junction box upright on the outside of the building so that the cables exit from the bottom of the junction box. This position ensures that the junction box components are not harmed by weather, especially rain. (See Table 9 on page 20 for recommended materials for mounting on a wall.)



**Note**

**CRIMP RINGS.** Use crimp rings to connect wires to a terminal or other screw. Crimp rings are not required, but can be used to keep the wires under control while making a good connection. Ten crimp rings are included in your kit:



- Five blue (16 to 14 AWG)
- Four yellow (26 to 24 AWG)
- One blue (6 AWG)

To use crimp rings:

- Strip 1.27 cm (0.5 inch) of covering from the wires.
- Slide crimp ring over wire ends, ensuring you cover the bare wires. Note that the crimp ring can not be removed easily after crimping.
- Using a crimping tool, crimp the ring over the wires so it forms a unit with the wires.
- Connect the wires to screw posts using the rounded metal end. (See Figure 20.)

Install the junction box

3. Connect the RAU cable to the junction box as shown in Figure 21 and Table 11.

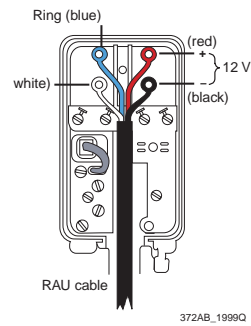

Figure 21. RAU cable

Table 11. Wiring from RAU to junction box

Wire	Signal
Black	+12 V return
Red	+12 V source
Blue	Ring
White	Tip

4. Secure all outdoor cables to stationary objects using cable ties (not included) to ensure that the cables are secured to the building and cannot be damaged by wind, animals, or vandals.
5. Close the cover to protect the contents from weather and vandals.

## Step 8. Run indoor wiring for the telephone and data



**Note**

If there is no wiring in the building, the installer needs to prepare the building for telephone service. Interior wiring should meet local standards.

Except for connecting to the junction box, the wiring instructions given here are all accomplished inside the building. Do not run wires designed for inside use on the outside of the building. You can connect as many as five phones.

### Connect interior wiring to jacks and telephones

1. Run all inside wiring before connecting the wires to the junction box. Wire telephones using standard telco wire.
2. Connect telco wire to interior jacks as described in Table 12.

**Table 12. Wiring from interior to junction box**

Signal	Color	RJ-11 Jack (6 pin)
Tip	Green	Pin 4
Ring	Red	Pin 3



**Note**

Do not apply power until you have completed the instructions in Step 9. Connect power supply on page 30.

### Connect interior wiring to the junction box

1. Run standard telco wire (not provided) from the interior rooms where the telephones will be located to the junction box. The wire distance between the junction box and the telephone farthest from the junction box should be no longer than 167 meters (550 feet). (See Figure 22.)



**Note**

Total wire length from RAU to farthest telephone must not exceed 182 meters (600 feet).

Total REN is not to exceed 5.0 B REN per Bellcore TA-NWT-000909.

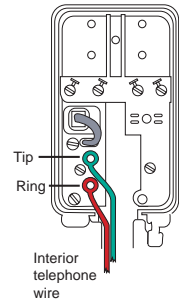

924AA\_1999Q

**Figure 22. Indoor connection**



**Note**

For best voice quality, avoid running the telephone wiring in close proximity to power lines or appliances.

2. After all wiring is complete, connect the telephones to the interior wired RJ-11 jacks.
3. With the power to the RAU off, connect the short phone cable inside the junction box to the RJ-11 receptacle. (See Figure 23.)

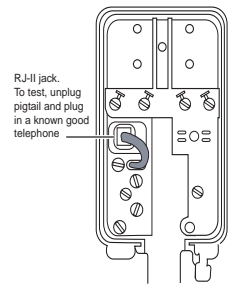

0856B 1050

**Figure 23. Jack**

Run indoor wiring for the telephone and data

## Selecting a telephone

QUALCOMM supplies a phone with the enhanced kit. If you are selecting a telephone, look for one that uses standard DTMF tones (industry standard tones), not pulses, for dialing.

For optimal results, a telephone should have good voice quality. Sound quality is determined by the telephone itself, as well as by signal reception.



### Note

You may need to try several telephones before you find one that satisfies your standards for voice quality when used with the QGFSP.

You can connect one or more telephones to the QGFSP. When using several telephones, an individual telephone should be 0.5 to 1.5 REN (ringer equivalency number).

The REN of the telephone is on the bottom of the telephone. Add the REN of all the telephones you intend to use. The total REN of all telephones that you connect to your telephone wiring must not exceed 5.0.

## Step 9. Connect power supply

You have some options in how you power your QGFSP:

- QUALCOMM Power Supply
- AC to DC converter
- Motor generator
- Battery power
- Solar panel

Each source of power requires installation that is unique to the type of power source. Follow the instructions provided with the power supply. In this section, we talk about how to connect the power supply to the QGFSP.

1. Run the power cord from the power source to the junction box. Normally, the power supply should provide 12 volts and at least 3 A. Voltage measured at the +12 V terminal of the junction box must be between 10.5 and 16 VDC.
2. Connect the power supply wires to the junction box as shown in Figure 24.

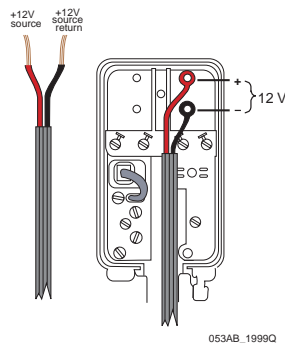

Figure 24. Wiring for power supply



### Note

Solar power may be installed between the RAU and the junction box. All other types of power connect only to the junction box.

### QUALCOMM Power Supply, Model GPO-1000

This is the power supply sold with the enhanced kit. It includes:

- Two 2.44 meter (8 foot) AC line cords for use in the U.S., South America, and Europe.
- 4.5 A/hour backup battery (average output of 12 V). The backup battery for the power supply offers approximately 3.5 hours of talk time or 24 hours of standby time.
- 12 VDC output cable at 7.5 meters (25 feet).

### AC to DC Converter

An AD/DC converter should operate at 100 to 240 VAC, 50/60 Hz, with output rated 12 VDC, 3 A.

### Motor Generator

A motor generator requires a two-wire terminal for 12 VDC.

### Battery Power

If you are using a battery for a power supply, use the instructions supplied with the battery.

### Solar Power

The solar panel must produce 12 VDC and usually includes a 12 volt backup battery.

Connect power supply

If you are using solar power, a configuration of the type shown in Figure 25 is recommended. Note that a larger pole is used to support the extra equipment.



**Note**

If using a solar panel, run power from the solar panel directly to the RAU. Do not run power down to the junction box and then up to the RAU. See Figure 25 for details.

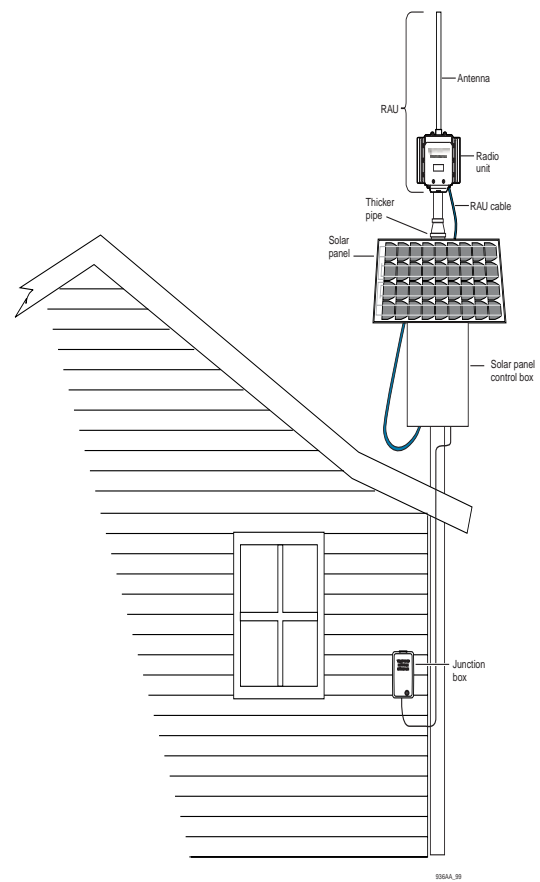

Figure 25. Suggested installation for solar power

## Step 10. Connect power and test

### Make sure that all cables are connected



#### Note

Do not supply power to the RAU or components until all the steps of assembly are complete. Use the following checklist to ensure that assembly is complete.

- Is the RAU mounted securely?
- Does the antenna have a clear, unobstructed view of the sky and the horizon in all directions?
- Is the junction box mounted on the outside wall?
  - Are all inside wires located inside the building?
  - Are only outside cables used on the outside of the building?
  - Is the wiring for the building complete and tested?
- Are all cables and jacks correctly connected and in place?
- Are all cables tied down?
- Do a visual check. Does everything appear to be in order?
- Are telephones and their wiring installed?
- Make corrections as needed.

### Check cable connections

In addition, be sure the following are done correctly.

- The RAU and the junction box are properly grounded.
- The junction box is installed.
- The RAU is connected to the junction box and the P clip inside the access cover of the RAU is tightened down.
- The power supply is installed (follow instructions provided with the power supply, if any).
- The 12 volt power wires are run to the power source.
- The inside wiring is installed for the telephones.
- The inside wiring is connected to the junction box.
- The security module is installed correctly.
- Access covers for the RAU and junction box are secured.
- Cables are secured to the pole for protection from the wind.



#### Note

It is safe to connect the telephone prior to or subsequent to applying power.

### Turn on power and perform power checks

When the checklist is done and you are confident that the equipment is installed correctly, turn on the power and perform power checks.

- Once the RAU has powered up and acquired the Globalstar system, you will hear a dial tone from the telephone receiver.
- Use a multimeter, or the equivalent, to ensure that the voltage at the junction box is between 10.5 and 16 VDC.



**Warning**

**POWER.** Do not apply 12 volt power until all electrical connections are made. Do not allow the +12 volt line to contact the ground wire or any other metallic object. Should a short occur, there is a risk of injury, fire, damage to the power supply, and explosive venting of any backup battery.



**Warning**

**FUSE.** For continued protection against the risk of fire, replace a blown RAU fuse only with an identically rated, certified fuse. The fuse is an IEC certified 3 A, 250 volt, 5 X 20 fast-acting ferrule fuse contained in a fuse holder. The fuse is underneath the front RAU access cover.

### Final check

If needed, do the following:

- Close and lock the RAU.
- Close and lock the junction box.
- Secure the cables to the pole.
- Inside the building, connect the telephones to the telephone jacks.

## Step 11. Troubleshooting

If one or more telephones fail to work, use the following troubleshooting procedure. These procedures should be used only by a qualified service technician.

1. If one telephone fails to work, check the wiring to that telephone.
2. If more than one telephone fails to operate:
  - Disconnect the building wiring from the QGFSP at the junction box. Do this by disconnecting the short cable in the junction box.
  - Connect a known good telephone to the jack in the junction box. See Figure 26.

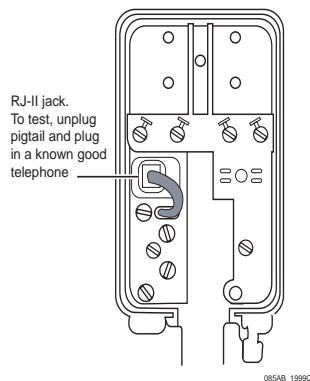

Figure 26. Troubleshooting

If the telephone works, the problem is in the building wiring.  
If the telephone still fails to work,

- Disconnect the telephone.
- Remove power to the QGFSP.
- Check the fuse on the power supply. If blown, check the power supply wiring before replacing the fuse.
- Check the fuse on the RAU. If blown, replace the fuse.

- If the fuse blew twice, check to see if
  - The power supply is not operating correctly
  - The RAU is broken
- Open the junction box and check all connections.



### Note

For continued protection against the risk of fire, replace a blown RAU fuse only with an identically rated, certified fuse. The fuse is an IEC certified 3 A, 250 volt, 5 X 20 fast acting ferrule fuse contained in a fuse holder.

3. If you fail to find a problem, reapply power to the RAU and check the voltage on the power supply screw terminals in the junction box. The voltage must be between 10.5 and 16 VDC.
4. If you still fail to find a problem,
  - Remove power to the RAU.
  - Open the RAU access cover and double check the connections within the RAU.
  - Check the RAU fuse. If blown, double-check the power supply wiring before replacing the fuse.
5. If you have followed this procedure and still have not found the source of this problem, remove the unit and return it to your service provider or a repair service designated by the service provider for evaluation and repair.

## Terminology

A	Amps
AWG	American Wire Gauge, a measurement of wire size
CCA	Circuit card assembly
Down conductor	The wiring that conducts electricity down into the ground. For example, the primary grounding cable from the RAU.
Ground terminals	Terminals for the purpose of grounding wires
IEC	International Electrical Council
NFPA	National Fire Protection Association (US)
OD or $\emptyset$	Outer diameter, used to measure pipe size
QGFSP	QUALCOMM Globalstar Fixed Satellite Phone.  A phone installation that uses the Globalstar system and CDMA technology. The QGFSP is fixed in place; that is, not portable
RAU	Radio Antenna Unit
SM	Security module, a device that authenticates the user of the telephone on the Globalstar system.
VAC	Volts AC
VDC	Volts DC

## References

- *Installation of Lightning Protection Systems, 1995 Edition*®.
- NFPA 780 Regulations, *Standards for the Installation of Lightning Protection Systems, 1995 edition.*
- NFPA 70, *National Electrical Code*®

## Appendix A. Standard practices for grounding

This information is provided for added safety and should be used in conjunction with Step 6. Ground the QGFSP.

The following standard practices are provided as good manufacturing processes for grounding. It is strongly recommended that you follow these practices for the RAU primary ground connection.

### Ground rods

Ground rods shall be not less than 12.7 mm (1/2 inch) in diameter and at least 2.4 meters (8 feet) long. Rods shall be copper-clad steel, solid copper, hot-dipped galvanized steel, or stainless steel. Rods shall be free of paint or other nonconducting coatings. Note that some types of soil may require a longer ground rod.



#### Note

Research has been presented warning that stainless steel is very susceptible to corrosion in many soil conditions. Use extreme caution and conduct a proper soil analysis when this type of rod is used.

### Separate RAU ground equipment

Electrical system and telecommunication grounding electrodes shall not be used in lieu of lightning ground rods. This shall not prohibit the required bonding together of grounding electrodes of different systems.



#### Note

IN NORTH AMERICA for further information see NFPA 70, *National Electrical Code®* and NFPA 780, *Standard for Installation of Lightning Protection Systems*, 1995 Edition©, which contain detailed information on the grounding of electrical systems.

IN OTHER COUNTRIES refer to the local lightning and electrical codes.

### Ground rod terminations

The down conductor shall be attached to the ground rod by bolting, brazing, welding, or using high-compression connectors listed for the purpose. Clamps shall be suitable for direct soil burial.

- **Deep moist clay soil**

The lightning conductors or ground rods shall extend vertically not less than 3 meters (10 feet) into the earth. The earth shall be compacted and made tight against the length of the conductor or ground rod.

- **Sandy or gravelly soil**

In sand or gravel, two or more ground rods, at not less than 3 meters (10 feet) spacings, shall be driven vertically to a minimum depth of 3 meters (10 feet) below grade.

- **Shallow topsoil**

Where bedrock is near the surface, the conductor shall be laid in trenches extending away from the building at each down conductor. These trenches shall be not less than 3.7 meters (12 feet) in length and from 0.3 to 0.6 meter (1 to 2 feet) in depth in clay soil. In sandy or gravelly soil, the trench shall be not less than 7.5 meters (24 feet) in length and 0.6 meter (3 feet) in depth. If these methods should prove impractical, an acceptable alternative would be to carry the lightning protection cable (or grounding cable) in trenches of a depth specified above. If this is impossible, carry the lightning protection cable directly on bedrock, a minimum distance of 0.6 meter (2 feet) from the

foundation or exterior footing and terminate by attaching it to a buried copper ground plate at least 0.8 mm (0.032 inch) thick and having a minimum surface area of 0.18 square meter (2 square feet).

- **Soil less than 0.3 meter (1 foot) deep**

If the soil is less than 0.3 meter (1 foot) in depth, down conductors shall be connected to a loop conductor installed in a trench or in rock crevices around the structure. The loop conductor shall be the equivalent of, or greater than, a main size lightning conductor. Optional plate electrodes may be attached to the loop conductor to enhance its earth contact where the measured grounding resistance is found to be too high to provide effective grounding.

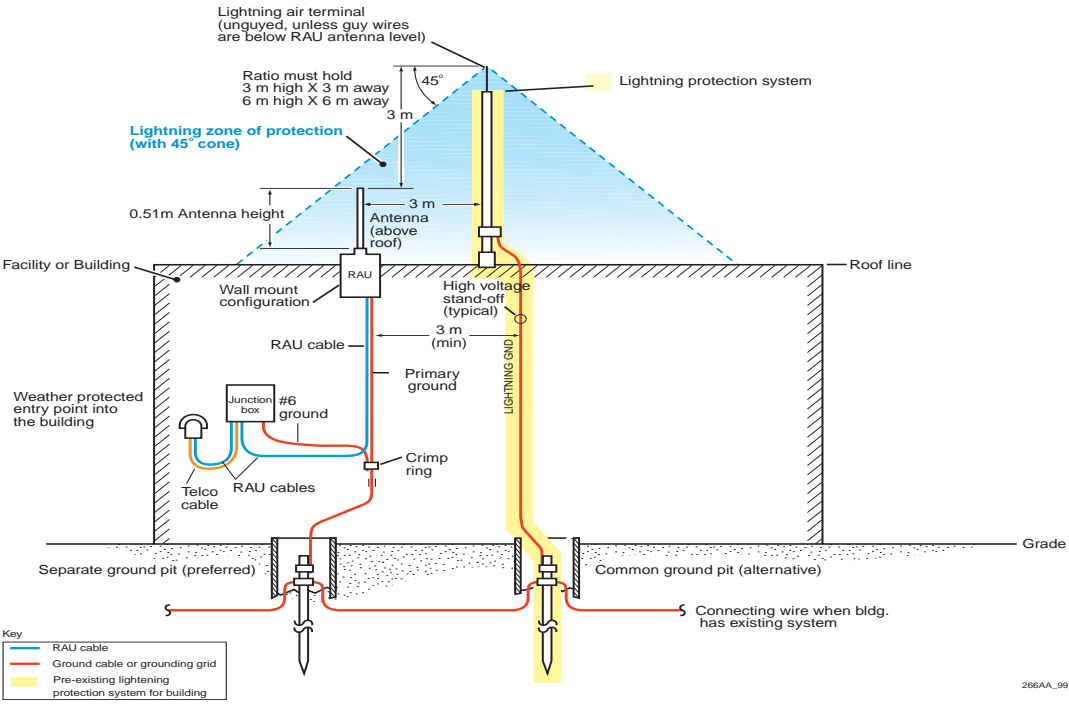

Figure 27. Grounding a building with existing lightning protection

## Appendix B. Specifications for Cables

Any cable used to connect the RAU and junction box must meet the following requirements.

### Conductors

Requirements are listed in Table 13.

**Table 13. Conductor Requirements**

Conductor Number	Description
1 to 2	To be used to transfer DC power to the radio. Must be 14 AWG (19/0.404) tinned copper wire (19/26) wire, unshielded, twisted pair). The conductors shall have a DC resistance not greater than 3.2 m ohm/ft at 80 degrees C.
3 to 4	To be used to carry telephone signals. Must be 24 AWG solid copper twisted pair (1 turn per 38.1 mm)

### Insulation

The individual conductors shall be insulated with semirigid insulation. The insulation shall be rated for at least 250 volts over a temperature range of -540 to +85 degrees C. The insulation shall be color coded so that each conductor is coded with a unique color. Conductors 1 and 2 shall be insulated with black and red insulation, respectively. Conductors 3 and 4 shall be insulated with blue and white insulation, respectively.

### Jacketing

The cable must be jacketed with a durable, all-weather jacket of polyvinyl chloride or thermoplastic elastomer. The jacket must be UV resistant and rated for a temperature range of -50 to +85 degrees C. It must protect the cable from the elements and/or water immersion. The jacketed cable shall be both durable and flexible.

## Environmental Requirements

Requirements are listed in Table 14.

**Table 14. Environmental Requirements**

Operating temperature	-50 to +85 degrees C
Storage temperature	-50 to +85 degrees C
Altitude	0 to 3,000 meters above Sea Level
Relative humidity	5 to 100%, with condensation

## Performance Criteria

Cable shall not degrade after exposure to the following conditions. The generic test data shall be made available on request by supplier. Criteria are listed in Table 15.

**Table 15. Performance Criteria**

Heat resistance	24 hours at 85 degrees C
Fluid resistance	24 hours at 50 degrees C JP-4 Fuel (MIL-T-5624) Hydraulic fluid (MIL-H-5606) Lubricating oil (MIL-L-23699) Lubricating oil (MIL-L-7808) 5% NaCl, 0-S-1926 De-icing fluid (MIL-A-8243) Water

### Cable Construction

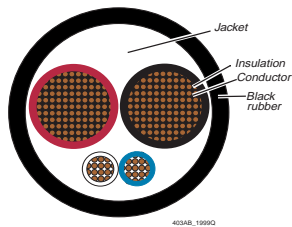

**Table 16. Cable Construction**

Conductors	14 AWG (19/-404) x 1P, tinned copper wire 24 AWG (1/0.511) x 1P, tinned copper wire
Insulation	PVC, 14 AWG x 1P: $\phi 2.8 \pm 0.1$ mm Color: black and red PVC, 24 AWG x 1P: $\phi 1.3 \pm 0.05$ mm Color: white and blue
Jacket	PVC black UV, $\phi 8.2 \pm 0.2$ mm
Operation temperature	-50 degrees C ~ +85 degrees C
Insulation resistance	DC/500V 20M min.
Withstand voltage	AC/250V 1mA, for one minute

The cable must be UV rated and have UL and CSA approval.

$\phi$  = outer diameter

## Appendix C. Operating Specifications



**Note**

Requirements for a particular installation site depend on the user's needs, location, climate, sun hours, call profile, and the length of autonomous operation desired. These specifications need to be determined by the service provider or service provider's representative.

### Power Specifications

**Table 17. Power specifications**

Power source	10.5 to 16.0 VDC, 3 A
Power consumption, RAU	30 Watts maximum

The power supply shall supply nominally 12 V DC. It shall support a load of up to 30 watts. Under no circumstances shall the output at the power supply ever drop below 10.5 V DC, even under a full load, or when switching to a backup battery. The output at the power supply shall not exceed 15.9 V DC.

### Mechanical Specifications

**RAU**

**Table 18. Mechanical specifications**

Width	21.6 cm (8.5 in.)
Height	25 cm (9.7 in.)
Weight	3.04 kg (6.7 lbs)

**Antenna**

**Table 19. Antenna**

Width	2.54 cm (1 in.) diameter
Height	50 cm (19.8 in.)

### Environmental Specifications

**RAU**

**Table 20. Environmental specifications**

Operating temperature	-30 to +60 degrees C
Storage temperature	-40 to +85 degrees C
Humidity	5 to 95%

## Appendix D. Third Party Equipment



### Note

QUALCOMM has tested and approved the products mentioned in this appendix, which may be used with the QGFSP at the user's/installer's discretion. However, all warranties and instructions for installation are provided by the supplier of the product.

### Product: SunWize™ Power Ready Systems

SunWize™ Power Ready solar electric power systems have been tested and approved by QUALCOMM for powering the QGFSP. SunWize Power Ready Systems consist of the following:

1. Solar electric module(s) with pole mounting structure and wiring
2. Charge controller with low voltage load disconnect
3. Sealed, maintenance-free battery
4. Weather resistant battery/control enclosure

A range of system sizes are available depending on average talk time and location. Contact SunWize for more detailed information, including pricing and availability.

SunWize Technologies, Inc.  
90 Boices Lane  
Kingston, NY 12401

Phone: (914-336-0146)  
Fax: (914-336-0457)

Web Site: <http://www.sunwize.com>

## Index

**A**

about satellites 1  
 AC to DC converter 11, 30  
 antenna location 1, 2

**B**

base kit 7  
 battery 5, 30  
   backup 9

**C**

cable construction 40  
 cable, telco 10, 28  
 checklist  
   connecting power 32  
   final 33  
   power 33  
 conductors 39  
 connecting power 32  
 converter, AC to DC 11, 30  
 crimp ring 7, 26

**E**

enhanced kit 7, 9  
 environmental requirements 39

**G**

grommet, installing 19  
 ground rod terminations 36  
 ground rods 36  
 grounding  
   standard practices 36  
 grounding accessories 10

grounding elements 23  
 grounding QGFSP 21  
   pole mount 21  
 grounding supplies 10

**H**

hex nuts 8

**I**

installation tools 11  
 insulation 39  
 interior wiring 10  
   installing 28  
   jacks and phones 28  
   junction box 28  
 inventory 7

**J**

jack, modular 10  
 jacketing 39  
 junction box 7  
   installing 25  
   interior wiring 28  
   positioning 14

**L**

lightning 6, 21  
   grounding 23  
 lightning rod 6, 23, 24  
 line of sight 2  
 locating antenna 1, 2

**M**

materials  
   needed 14

materials, wall mount **20**  
 mechanical specifications **41**  
 motor generator **11, 15, 30**  
 mounting bracket **9**  
 mounting bracket (A) **8**  
 mounting clamp (B) **8**  
 mounting kit **8**  
 mounting RAU **2, 18**

**P**

pan head screws **8**  
 performance criteria **39**  
 positioning **12**  
 positioning components **12**  
 power  
   connecting **32**  
   turning on **33**  
 power checks **33**  
 power source positioning **15**  
 power specifications **41**  
 power supply **9, 11, 15**  
   AC to DC converter **30**  
   battery **30**  
   connecting **30**  
   motor generator **30**  
   QUALCOMM **30**  
   RAU cable **17**

**R**

radio antenna unit (RAU) **7**  
   connections **16**  
   ground equipment **36**  
   mounting **2, 14**  
   pole mount **12, 18**

  pole size **18**  
   preparing **16**  
   roof mount **12**  
   specifications **18**  
   supporting pole **10**  
   wall mount **20**  
 references **35**  
 ringer equivalency number (REN) **29**

**S**

safety considerations **5**  
 security module **7**  
   preparing **17**  
 sighting tool **2, 7**  
 solar panel **11, 15, 30**  
 SunWize **11, 42**

**T**

telephone, connecting **29**  
 telephone, selecting **29**  
 terminology **35**  
 theft prevention **19**  
 tools, installation **11**

**U**

U bolt **8**

**W**

wall mount materials **20**  
 wall mounting bracket **20**  
 washers  
   flat **8**  
   split lock **8**  
 wire **9**  
 wiring boxes **10**